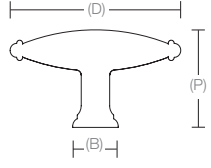

TUSCANY BRONZE

Cabinet Knobs & Pulls Technical Specifications

EMTEK

Tuscany Bronze Fluted Finger Knob

		Product Code	Dimension(D)	Projection(P)	Base Diameter(B)	Width(W)
		86227	1 3/4"	1 1/4"	11/16"	9/16"
		86228	3"	1 5/8"	13/16"	11/16"

Tuscany Bronze Twist Knob

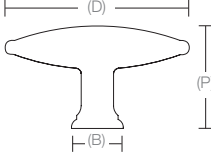
		Product Code	Dimension(D)	Projection(P)	Base Diameter(B)	Width(W)
		86097	1 3/4"	1 1/4"	11/16"	9/16"
		86098	3"	1 3/4"	13/16"	11/16"

Tuscany Bronze Fluted Knob

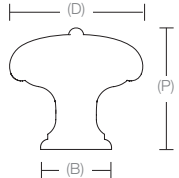
		Product Code	Dimension(D)	Projection(P)	Base Diameter(B)
		86229	1"	1 1/8"	5/8"
		86230	1 1/4"	1 1/4"	11/16"
		86231	1 3/4"	1 1/2"	13/16"

Tuscany Bronze Twist Round Knob

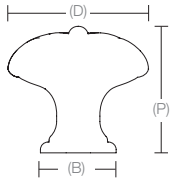
		Product Code	Dimension(D)	Projection(P)	Base Diameter(B)
		86244	1"	1 1/8"	5/8"
		86245	1 1/4"	1 1/4"	11/16"
		86246	1 3/4"	1 1/2"	13/16"

Tuscany Bronze Egg Knob

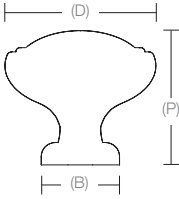
		Product Code	Dimension(D)	Projection(P)	Base Diameter(B)
		86093	1"	1"	5/8"
		86094	1 1/4"	1 1/4"	11/16"
		86143	1 3/4"	1 1/2"	13/16"

Tuscany Bronze Petal Knob

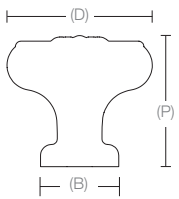
		Product Code	Dimension(D)	Projection(P)	Base Diameter(B)
		86095	1"	1"	5/8"
		86096	1 1/4"	1 1/4"	3/4"
		86214	1 3/4"	1 1/2"	7/8"

TUSCANY BRONZE

Cabinet Knobs & Pulls Technical Specifications

EMTEK

Tuscany Bronze Round Knob

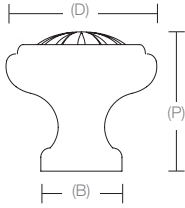
		Product Code	Dimension(D)	Projection(P)	Base Diameter(B)
		86091	1"	1"	5/8"
		86092	1 1/4"	1 1/4"	3/4"
		86116	1 3/4"	1 1/2"	13/16"

Tuscany Bronze Octagon Knob

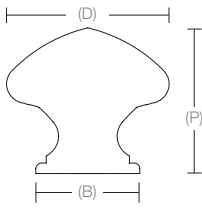
		Product Code	Dimension(D)	Projection(P)	Base Diameter(B)
		86137	1"	1"	3/4"
		86138	1 1/4"	1 1/4"	3/4"
		86215	1 3/4"	1 5/8"	1"

Tuscany Bronze Ribbed Pull

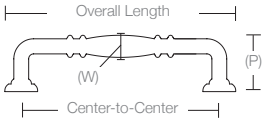
		Product Code	Overall Length	Dimension C-to-C	Projection(P)	Width(W) Center Only
		86100	3 5/8"	3"	1"	7/16"
		86101	4 1/8"	3 1/2"	1"	7/16"
		86102	4 5/8"	4"	1"	7/16"
		86255	6 5/8"	6"	1"	1/2"

Tuscany Bronze Fluted Fixed Pull

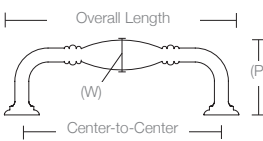
		Product Code	Overall Length	Dimension C-to-C	Projection(P)	Width(W) Center Only
		86218	3 5/8"	3"	1 1/2"	5/8"
		86219	4 1/4"	3 1/2"	1 1/2"	5/8"
		86220	4 5/8"	4"	1 1/2"	5/8"
		86221	6 5/8"	6"	1 1/2"	11/16"
		86222	8 5/8"	8"	1 1/2"	11/16"
		86223	10 5/8"	10"	1 1/2"	11/16"

Tuscany Bronze Twist Fixed Pull

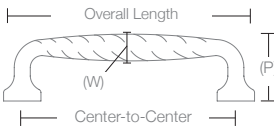
		Product Code	Overall Length	Dimension C-to-C	Projection(P)	Width(W)
		86103	3 5/8"	3"	1 1/4"	1/2"
		86104	4 1/4"	3 1/2"	1 1/4"	1/2"
		86105	4 5/8"	4"	1 1/4"	1/2"
		86238	6 5/8"	6"	1 3/8"	9/16"
		86239	8 5/8"	8"	1 3/8"	5/8"
		86240	10 5/8"	10"	1 3/8"	5/8"

TUSCANY BRONZE

Cabinet Knobs & Pulls Technical Specifications

EMTEK

Tuscany Bronze Bin Pull

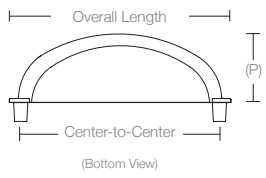
		Product Code	Overall Length	Dimension C-to-C	Height	Projection(P)	Width(W)
		86099	3 1/2"	3"	15/8"	1"	13/8"
		86199	4 3/8"	4"	2"	1"	15/8"

Tuscany Bronze Fluted Bin Pull

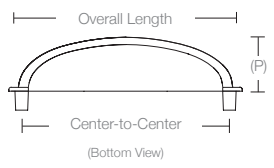
		Product Code	Overall Length	Dimension C-to-C	Height	Projection(P)	Width(W)
		86232	3 3/8"	3"	1 3/4"	1"	1 1/2"
		86233	4 3/8"	4"	1 7/8"	1"	1 5/8"

Tuscany Bronze Back Plate for Knob

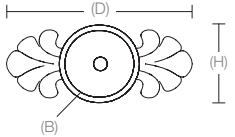
		Product Code	Dimension(D)	Height(H)	Diameter(B)
		86234	2 1/4"	7/8"	1"

Tuscany Bronze Back Plate for Pull

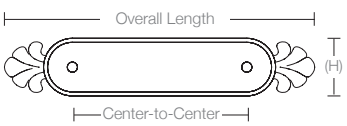
		Product Code	Overall Length	Dimension C-to-C	Height(H)
		86235	5 1/4"	3"	7/8"
		86236	5 3/4"	3 1/2"	7/8"
		86237	6 1/4"	4"	7/8"